

Article number: 201240105

Description: E+G Retaining magnets with smooth stud GN 52.4-ND-6-M3-E
Neodymium, iron, boron - 80° C, 6N

Measures

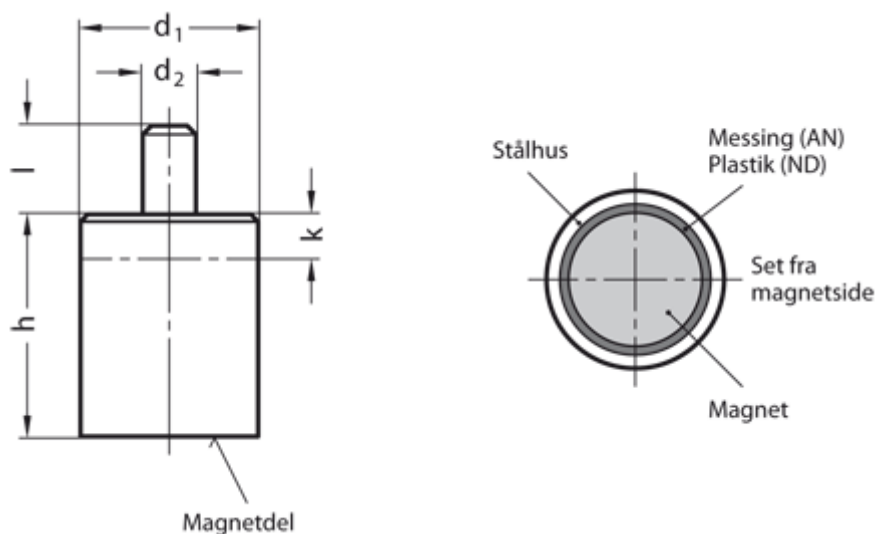

d1 = 6

d2 = 3

h = 20 ±0,2

Holding force N = 6.0

k = 12 mm - Max. dimension the magnet can be shortened

l = 8

Material = ND Neodym, iron, boron, 80°C